



### **[Features]**

- **Color LCD enables to show various information**  
 As well as current position, the high resolution color LCD can show the running program, motor information and more.
- **Easy to input a program**  
 In editing program, interactive display screen prevents easy mistakes.
- **Reduce indexing time**  
 Adopting EtherCAT enables high speed communication and shortens the time of indexing.
- **Easy to manage programs**  
 Input/output programs and parameters can be managed by MMC (Multi Media Card) that is on the market.

■ **Two types of panels with different operational feeling**

Touch panel type that follows up soft operation and quick operation.  
Click emboss panel type (CS) that offers a sense of security with a firm click feeling.

■ **Select motors in accordance to a use or environment**

There are many variations of motors, and a motor suitable for a particular machining condition can be selected.

**【Selectable motor list】**

Quinte		Single Axis	Double Axis	Powered
Model		QTC100/QTC100CS	QTC200/QTC200CS	QTC300
Matching motor	200W	○	○	—
	400W	○	○	—
	750W	○	○	—
	1000W	○	○	—
	1200W	○	○	—
	1800W	—	—	○
	2000W	—	—	○
	3500W	—	—	○

■ **To use extension I/O enables a variety of usage**

To use extension I/O option enables to select programs and to output WZRN position and M signal from machines.

■ **Manual pulse generator is available**

Manual pulse generator is available to all models as option.

■ **Compatible with a remote control function**

Remote control function by serial communication with machine is available as an option.  
Operation confirmed CNC manufacturer and machine manufacturer.  
FANUC CORPORATION, Mitsubishi Electric Corporation, Okuma Corporation,  
Yamazaki Mazak Corporation, BROTHER INDUSTRIES, LTD.

■ **Conforming to CE and KC standard**

As well as EMC Directive, all models conform to KC mark.

■ **Compatible with absolute encoder 【Custom support】**

Batteries are unnecessary with the adoption of a battery-less absolute encoder\*1. Coordinates never deviate even with reconnection after removal of cables for Quinte and the rotary table.

\*1 Quinte battery is used for the system. However, since power consumption is very small, battery replacement is unnecessary.

## Outside view / Dimensions

### ■ QTC100 / QTC100CS

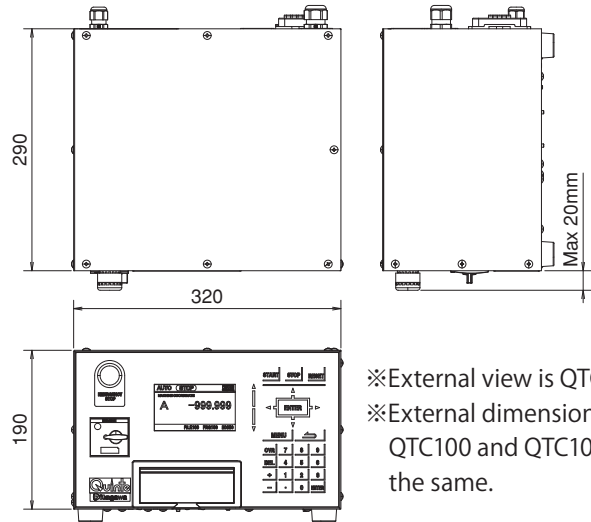

※External view is QTC100.  
 ※External dimensions of the QTC100 and QTC100CS are the same.

### ■ QTC200 / QTC200CS

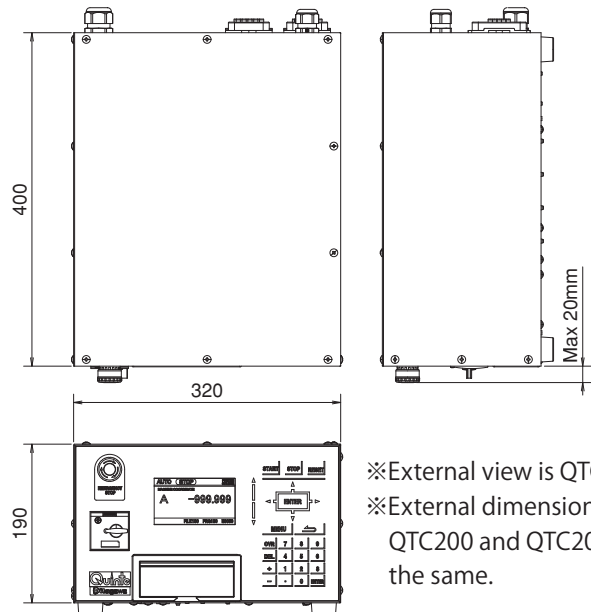

※External view is QTC200.  
 ※External dimensions of the QTC200 and QTC200CS are the same.

### ■ QTC300

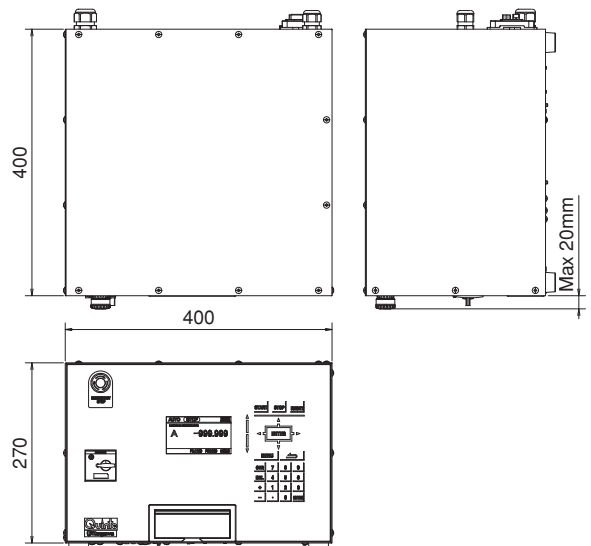

## Quinte Specification

Item	Quinte		
	Single Axis	Double Axis	Powered
	QTC100 / QTC100CS	QTC200 / QTC200CS	QTC300
Controlled axes	1 axis	2 axes	1 axis
Servo Motor	AC servo motor with absolute detector		
Setting Unit	0.001° / 0.0001° (Can be changed by parameters) : 0.001°		
Controlled unit	0.0001°		
Max. setting angle	9999 rotation +360° ±999.999°		
Equal partition	0~9999 partition (divisible to sector)		
Program capacity	Max.program No. 999, Max.2000 blocks per program (depending on program capacity)		
Command method	Absolute / incremental methods(selectable G90/G91)		
Zero position return	Machine zero return and Workpiece zero return(commandable by external input)		
Manual feed	Rapid traverse, slow speed feed, step feed		
EM Stop	Emergency stop button or forced servo stop by the external interlock input+master stop		
	Two pairs of EM stop wires output signal available		
Halt	Halt of rotary table by key input or external SP input		
Feedrate override	Settable to 1-200% (Can be notched to 1-100%)		
Preparatory function (G code)	Dwell, Lead Cutting, Buffer function, Clamp presence, Deviation check function, Interlock start, continuous start, Machine zero return, Workpiece zero return, Repeating function, Loop jump function, Absolute/Incremental, Fin signal control command		
Sub-program function	Enable at M98 command		
Uni-directional approach	Even if rotary direction is changed, positioning from uni-direction is available		
Software limit function	Software limit can be set from machine zero position to prevent interference with the machine by mounting jigs or workpiece.		
Over travel stop function	The hard limit mode can control the rotary range of rotary table		
Backlash compensation	The backlash compensation of rotary table can be set.		
Remote control function	The rotary table is operated by transferring program data for the machine and starting the transferred program.		
Auto notch filter function	Notch filter is automatically detected and can be set up to four stages to suppress machine vibration.		
Alarm function	In case of Error detected, alarm No. and alarm message are automatically displayed. 100 Alarms history log are displayed		
Angle display	Machine coordinate, Work coordinate, Relative coordinate Remained shift, Overall coordinate		
Comment display function	Comments can be added to program data files and programs, and can be displayed on the screen.		
Input power	Single / 3 phases AC200-230V±10% 50/60Hz (Std. 3 phases)		
Power requirement(A)	30	30×2	100
Dimensions(mm)	320(W)×190(H)×290(D)	320(W)×190(H)×400(D)	400(W)×270(H)×400(D)
Mass of product(kg)	10.0	13.0	19.0
Environment	Use temperature : 0 ~ 45°C    Store temperature : -10°C ~ 60°C Use humidity : 20~80% Rh or less (dew condensation, freezing not to be found) Vibration proof : 0.5G or less    Shock resistant : 1G or less Ambient atmosphere : to pollution level 3 (However, do not wet directly with water or oil)		
Display	TFT color liquid crystal 480x272 dot		
External I/O signal	(Input) Start, Stop, External EMG Stop1, External EMG Stop2 (Output) Block completed, EMG Stop output signal1, EMG Stop output signal2, Alarm output signal(B-contact)		
Multiple choice I/O signal (Option)	(Input : 6) Ext Workpiece zero return request 1, Ext Workpiece zero return request 2, Ext Machine zero return request 1, Ext Machine zero return request 2, Ext Program select 1-5, Ext Program set, Ext Auto operation function, Ext reset, Over travel, M Fin signal 1-6 (Output : 6) Workpiece zero return completed 1, Workpiece zero return completed 2, Machine zero return completed 1, Machine zero return completed 2, Workpiece zero return position confirmation 1, Workpiece zero return position confirmation 2, Machine zero return position confirmation 1, Machine zero return position confirmation 2, Alarm signal output(A-contact), AUTO mode selected, External program select completed, External program No. output 1-6, M signal output1-6 ※Can be used from the above signals by parameter layout.		
MMC Slot	Programs and parameters can be uploaded or downloaded by memory card		

## Quinte front surface

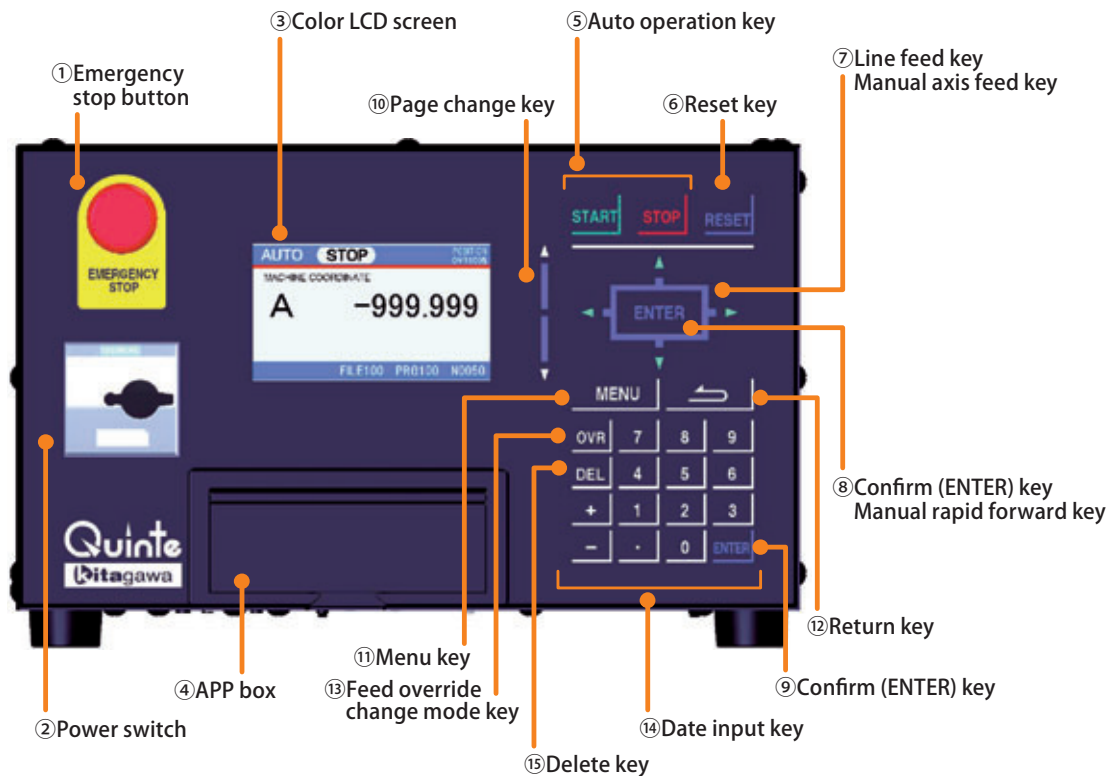

### ① Emergency stop button

Stop the table during operation in an emergency.

### ② Power switch

Turn ON/OFF controller power.

### ③ Color LCD screen

Display current position, programs, parameters and more.

### ④ APP box

Battery and MMC slot are in the APP box.

### ⑤ Auto operation key

The key to start and stop the program.

### ⑥ Reset key

Reset programs and alarms.

### ⑦ Line feed key/Manual axis feed key

The key is for cursor movement and for jog feed operation in manual mode.

### ⑧ Confirm (ENTER) key/Manual rapid forward key

Determine and confirm things that have been selected and perform a Manual rapid forward by sliding from the manual axis feed key in the manual mode.

### ⑨ Confirm (ENTER)key

Determine and confirm input for each part, popup etc., in various ways.

### ⑩ Page change key

The key to change the page.

### ⑪ Menu key

Display menu window.

### ⑫ Return key

Return to the previous screen

### ⑬ Feed override change mode key

Adjust the feed speed.

### ⑭ Date input key

Input program and data.

### ⑮ Delete key

Delete one letter of numerical values input such as program or parameter.



## LCD EXAMPLES

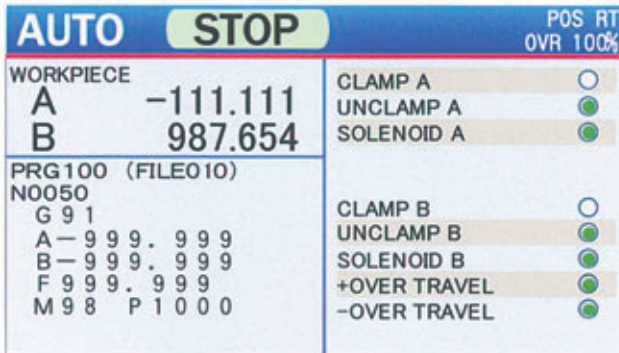

### 【Screen for Auto mode】

Monitoring the present coordinate (machining coordinate), programming and condition of the Rotary table in real-time.



### 【Present coordinate screen at manual mode】

Enlarged to show present coordinate  
At the bottom of the screen, the wizard for origin return and Jog operation are displayed.



### 【Program edit screen】

Reducing the mistakes and shortening the programming time are expected through inserting the section corresponding to the code

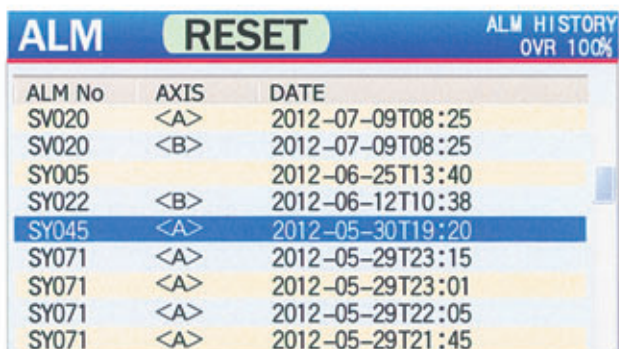

### 【Alarm history screen】

This screen displays history of the past 100 alarms.

## PROGRAM EXAMPLES

### ANGLE INDEX

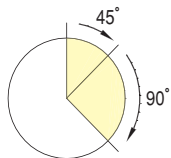

```
N0000 A 45.000 F0
      Index angle Rapid traverse
N0001 A90.000 M30
      Jump destination
```

Rotates 45° at rapid traverse and returns to N0000 after rotating 90°

### EQUIPARTITION

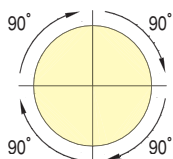

```
N0000 A360.000 F0 D4 M30
      Partition angle Divided partition
```

Rotates with circle of 360° divided into 4-partition (every 90) at rapid traverse and returns to N0000 after operating 4 times.

### UNEQUAL PARTITION

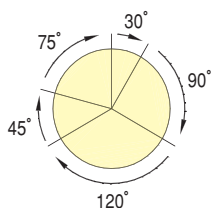

```
N0000 A 30.000 F0
N0001 A 90.000
N0002 A120.000
N0003 A 45.000
N0004 A 75.000 F5.000 M30
                Feed rate
```

Rotates 45° at rapid traverse, 90°, 120°, 45° and 75° at federate 5.000min<sup>-1</sup> before returning to N0000.

### ABSOLUTE / INCREMENTAL

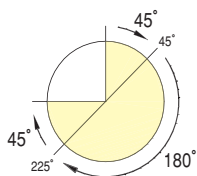

```
N0000 G90 A45.000 F0
      ABS command Index position
N0001 A225.000
      Index position
N0002 G91 A45.000
      INC command Partition angle
```

Rotates 45° at rapid traverse under absolute mode, Rotates 225°. Rotates 45° under incremental mode.

### SUBPROGRAM

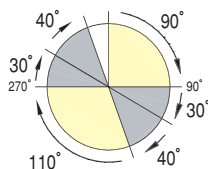

```
PRG001
N0000 A90.000 F0
      Subprogram repeating times
      M98 P002 L1
      Subprogram command Subprogram jump destination

N0001 G90 A270.000 M98 P003 L1

PRG002
N0000 G91 A30.000
N0001 A40.000 M99
      Subprogram end

PRG003
N0000 G91 A30.000
N0001 A40.000 M99
```

Program No.1  
Rotates 90° at rapid traverse and jumps to PRG002  
Rotates 270° at rapid traverse under absolute mode and jumps to PRG003

Program No.2  
Rotates 30° under incremental mode  
Rotates 40° and returns to original subprogram command point

Program No.3  
Rotates 30° under incremental mode  
Rotates 40° and returns to original subprogram command point

# Connection

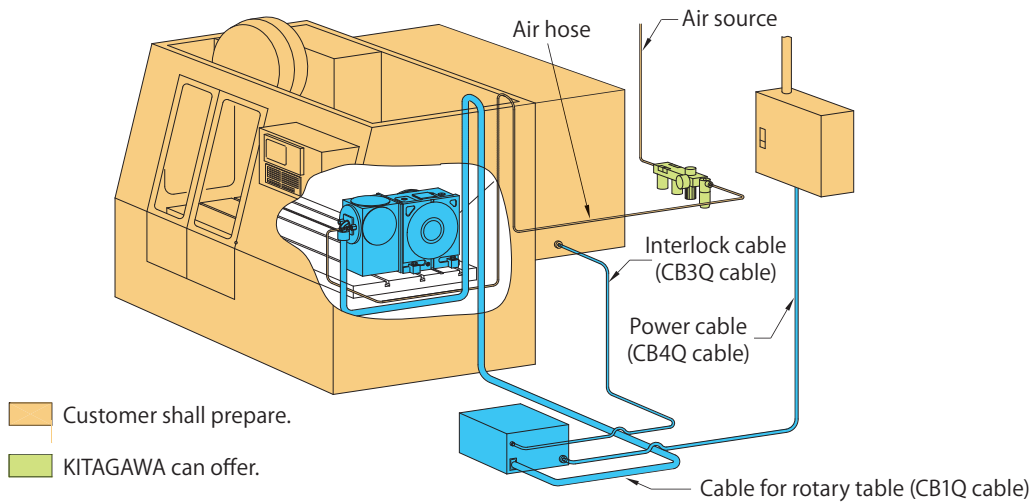

## Power Supply

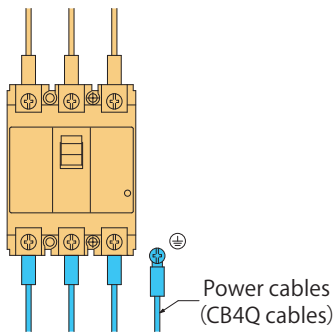

Supply power to controller.  
Customer shall prepare exclusive circuit breaker.  
Specifications of circuit breaker are as follows:

Type	Capacity
QTC100/QTC100CS	10A
QTC200/QTC200CS	15A
QTC300	20A

Connect an earth wire of Class D (Class No. 3). Moreover, when the earth leakage breaker is used, it is recommended to use the breaker for which sensitivity current is 100mA or more, an operation time is 0.1 second or more, or a high frequency measure is taken in order to prevent the motor from the malfunction caused by a motor's high frequency.

## Connection for external interlock

When the rotary table is interlocked with the external equipment, it is need to be controlled with M signals from the external equipment.  
The external equipment must be equipped with the connection (terminal board) for M signal OUTPUT, M signal completed INPUT etc., by machine maker.

## Air Supply

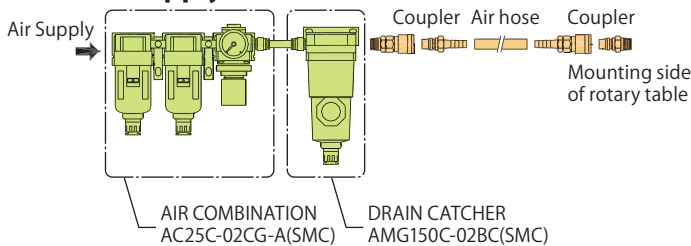

The rotary table is clamped by air.  
Therefore, please prepare the following components.

- Air combination
- Drain unit
- Air hoses or air tubes (incombustibility)
- Couplers for connection

※Air-Unit should have the specification with Auto drain port

## Air Diagram

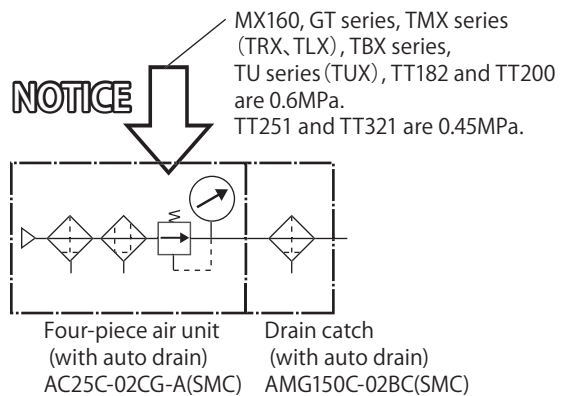



## Mutual Connection diagram

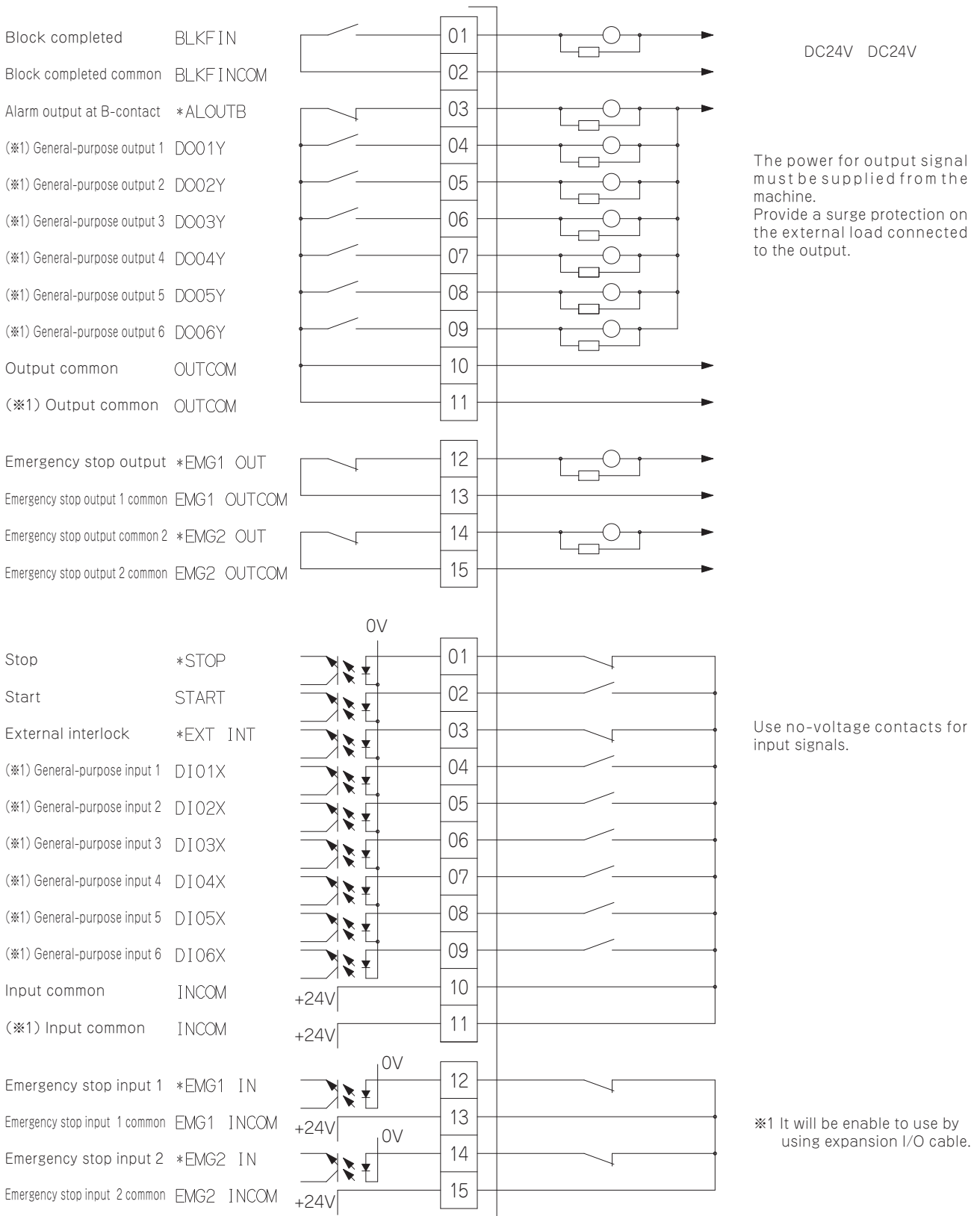

# Machine Connection Diagram (Example)

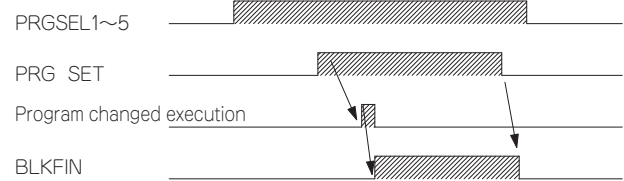
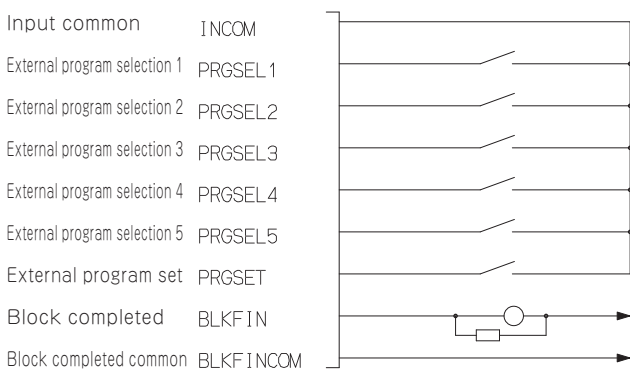
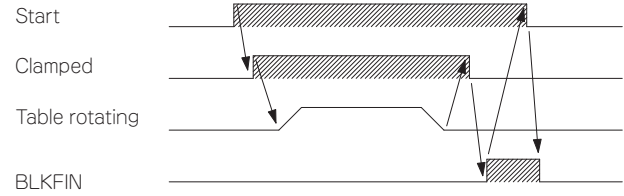
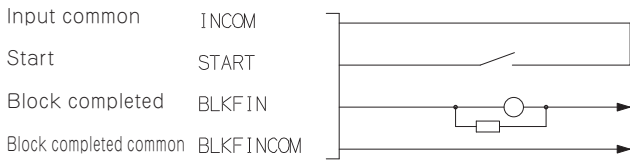

※The program available on binary mode are PRG001 through PRG31.  
PRGSEL PRGSEL

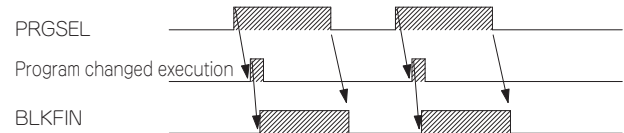
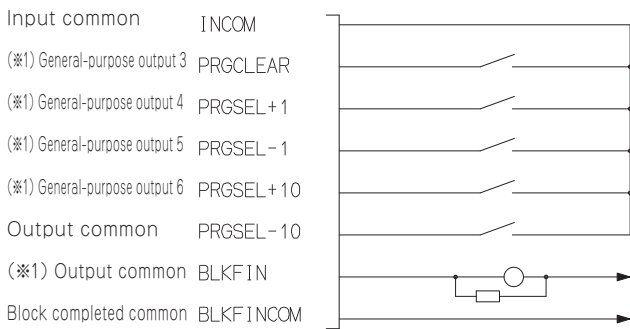

※The channels available on M-signal mode are PRG001 through PRG999.

※For external program selection, extension I/O option is required.

## Control Flow-Chart

It is in principle recommended for Kitagawa's NC rotary table control to turn the servo OFF while clamping.

### Semi-/Full-Closed Loop

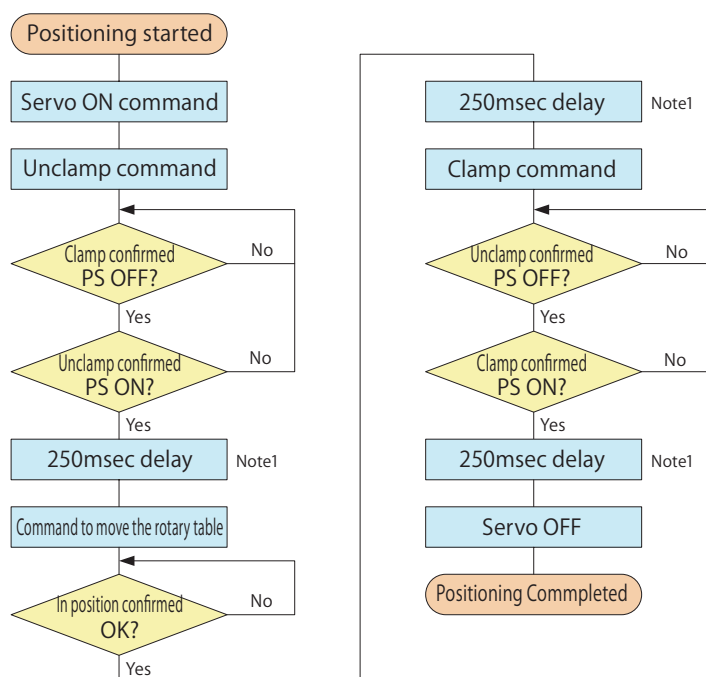

Note1) The delay timing here is a recommended value. It may differ with different parameters or specifications.

## Methods for Controlling NC Rotary Table

### Additional-Axis Method

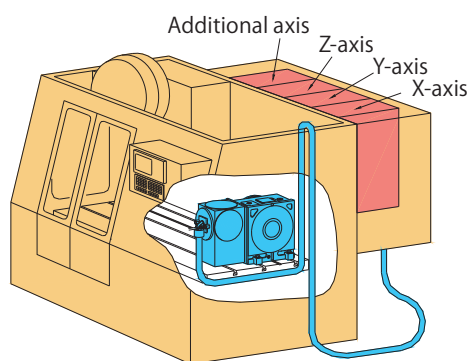

#### [Feature]

- ◆ NC Rotary Table is controlled as the NC Axis of the machine.
- ◆ Interpolation machining is possible with X-, Y- and Z-axis of the machine.
- ◆ Program can be controlled on the machine.

### M-Signal Method

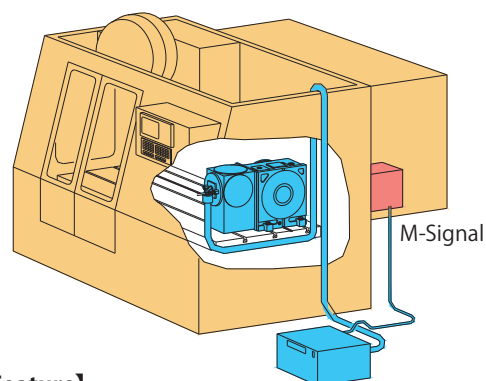

#### [Feature]

- ◆ NC Rotary Table is controlled by a separate controller, and not as the NC Axis of the machine.
- ◆ NC Rotary Table can be fitted with machine with no compatibility for an additional axis, as long as M-signal is available.
- ◆ NC Rotary Table can easily be transferred to another machine.

## Quinte Series OPTION

### ■ Manual Pulse Generator (Holder attached)

This pulse generator can operate the table at 0.1°, 0.01° and 0.001°, and it adjusts jig easily. The QTC200 series can support with one hand-operated pulse generator by an axis select.

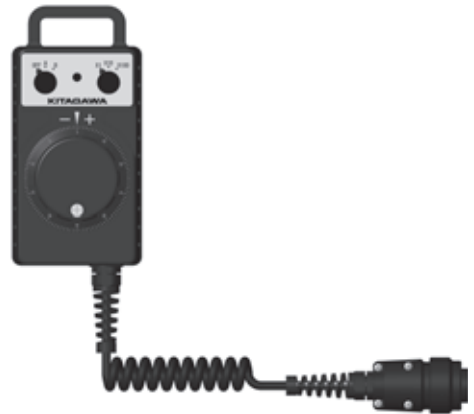

### ■ Manual pulse generator internal cable [HC1-IC-Q]

A relay cable for the inside of the Quinte panel is necessary for use of the manual pulse generator. A dust cap and 4 installation screws are included with the HC1-IC-Q.

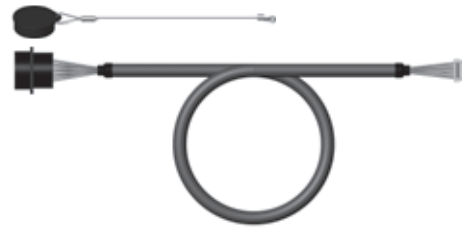

### ■ Extended I/O cable (5m)

With the Expansion I/O cable, extended functions like External program selection, M signal output and more are enabled.

- ※For the enable signals, refer to multiple choice I/O signal on the Quinte Specification page.
- ※Cable length can be changed.



### ■ Remote control function cable (5m)

#### ○ RS232C Cable [RSCB0909/RSCB0925]

In order to use the remote control function, a RS232C Cable (for use between machines) is required.

RSCB0925 is 9-25 pin, and RSCB0909 is 9-9 pin.

Please select according to the shape of the RS232C port on the machine side.

- ※Cable length can be selected from 2m/3m/5m.

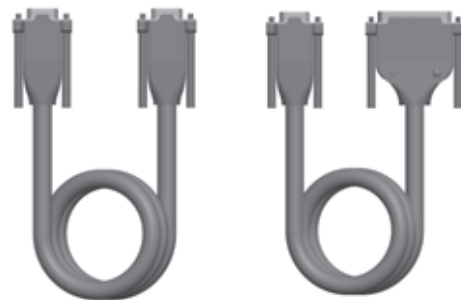

[RSCB0909]

[RSCB0925]

#### ○ Remote relay cable [RC2-IC-Q]

In order to use the remote control function, a relay cable for inside the Quinte panel is required. A dust cap and 4 installation screws are included with the RC2-IC-Q.



## Quinte Series OPTION

### ■ For Kitagawa own controller Quinte series Manual Operation Pendant

#### 【Features】

- Enables to operate NC rotary table with watching its movement closer  
Easy holding style with one hand expands operating range  
Light weight cable allows high-accessibility to fixtures
- OEL display  
The light-emitting character with a high contrast ratio achieves high visibility even in a dark place or machine.
- Smooth touch operating key switches  
Achieve smooth operability without moving part in the operation part and key layout by function.
- Water and dust resistance  
Ensure water and dust resistance by the protection grade IP54.
- Easy installation by a strong magnet  
Able to be temporarily placed on vertical surface without sudden fall off.
- Able to be additionally installed to Quinte  
MOP is available with Quinte by installing a dedicated cable to Quinte and updating the F / W of Quinte.



#### ■ Dimensions



#### ■ Specifications

##### ● Display specifications

Display device	OEL display
Display type	Character display
Display resolution	20 characters × 4 lines

##### ● Operating specifications

Operating type	Capacitance switch, mutual capacitance type
Enable switch	2 positions
Buzzer	Frequency:3520Hz Sound pressure:0~75dB(10 steps)

##### ● Environmental specifications

Operating temperature range	0~45°C
Operating humidity range	Less than 20~80%RH(no condensation)

##### ● Structure specifications

Cable length	3m
Protection structure	IP54(Except cable connector part)
Mass	450g (Except cable)

#### ■ Option

##### ● MOP internal cable [MOP-IC]

When using MOP, a relay cable to the inside Quinte panel must be prepared.  
4 screws are supplied with MOP-IC for installation.



##### ● MOP Dummy Connector [MOP-DCN]

Connector for short-circuiting an emergency stop circuit when not connected to MOP.  
In case using one MOP to plural Quinte units, MOP-DCN is needed for Quinte which is not connected to MOP.  
MOP-DCN is needed to cancel the emergency stop.



## Manual operation pendant features

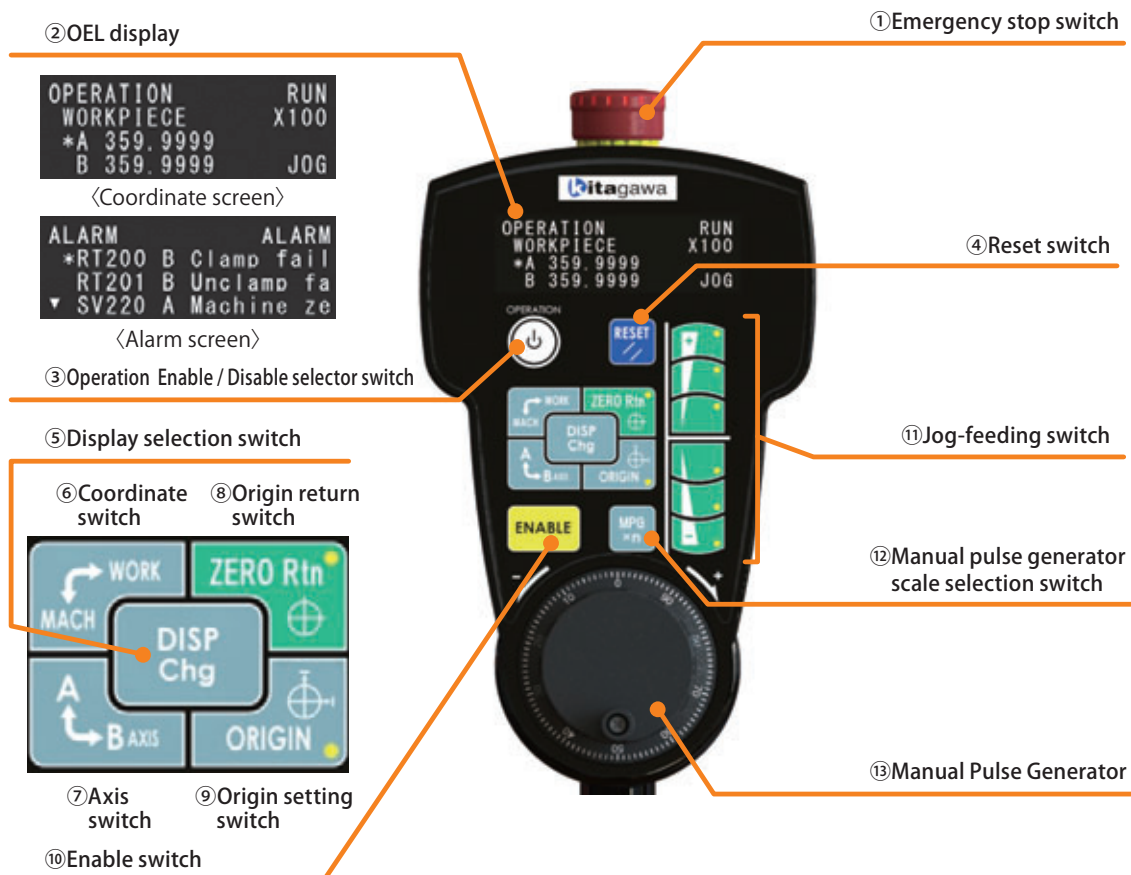

### ① Emergency stop switch

Emergency stop for NC rotary table in operation.

### ② OEL display

Display coordinate system, coordinate data and operation state.

### ③ Operation Enable / Disable selector switch

Prevent unintended erroneous operations by selecting the Enable / Disable of the MOP operation.

### ④ Reset switch

Reset the alarm.

### ⑤ Display selection switch

Switch the coordinate screen and alarm screen.

### ⑥ Coordinate switch

Switch machine coordinate and work coordinate.

### ⑦ Axis switch

In case using MOP for QTC200 series, switch axis operating (axis A/B)

### ⑧ Origin return switch

Return to original position. ※1

### ⑨ Origin setting switch

Set the origin. ※1

### ⑩ Enable switch

This switch will allow the operation such as JOG, returning to zero position, and origin setting which unintended changes might lead to dangerous. ※2

### ⑪ Jog-feeding switch

JOG operation of the NC rotary table.

Select 3 levels of the rotating speed.

While operating reset switch and jog-feeding switch at the same time, the buzzer volume can be adjusted.

### ⑫ Manual pulse generator scale selection switch

Select the pulse magnification.

### ⑬ Manual Pulse Generator

Generate pulse for operating NC rotary table.

※1 This switch is for the axis and coordinate systems which selected at ⑥ and ⑦.

※2 Simultaneously operated with keys which have the yellow ● marks on the right side.